



Verona Series



Verona Series

HOPPE Verona Series – 1510/42K

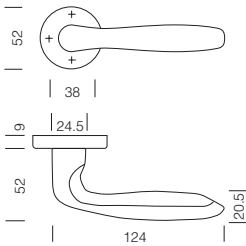

Lever on Round Rose

features

- Supplied with bolt through fixings - AR200FP (701742)
- Supplied with HOPPE 100mm patented split profile spindle (517572)
- Suitable for 40mm to 47mm door thickness
- Longer spindles available for thicker doors: See end of this section
- Nylon understructure – 4 point fixing
- Suitable for 30min and 1 hour fire door
- LRV Rating: HOPPE F1 Finish LRV of 60

standards and certification



Quality & Performance: Successfully type tested to all the requirements of BS EN1906: 2002 Grade 2 (Test reports/certificates are available on request)
*Note: this classification only applies to the product marked with an asterisk

2	6	-	1*	1	4	0	A
---	---	---	----	---	---	---	---



Fire Safety: Included on a successful fire test to BS EN1634 Part1: 2002. Assessed for use on 30 min, & 1 hour fire doors.



Manufactured by an ISO 9000 Registered Company

ID NO	PRODUCT REF	DESCRIPTION	FINISH
797103	AR280/10-SP-SAA*	Sprung lever on round rose	SAA (F1)
2069941	AR280/10-UN-SAA	Unsprung lever on round rose	SAA (F1)

HOPPE Verona Series – 1510/267U

Lever on Concealed Fix Rectangular Plate (sprung)

features

- Supplied with 8mm x 105mm full profile spindle (630905)
- Supplied complete with bolt through and wood screw fixings – AR200FP (701742)
- Suitable for 41mm to 50mm door thickness
- Longer spindles available for thicker doors: See end of this section
- LRV Rating: HOPPE F1 Finish LRV of 60

standards and certification

 Manufactured by an ISO 9000 Registered Company

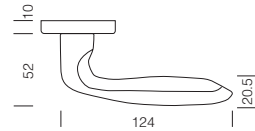

ID NO	PRODUCT REF	DESCRIPTION	FINISH
8565415	AR280/11-SAA	Sprung long plate latch furniture	SAA (F1)
8565422	AR280/12-SAA	Sprung lock furniture 57mm centres	SAA (F1)
8565429	AR280/13-SAA	Sprung euro profile lock furniture 47.6mm centres	SAA (F1)
8565436	AR280/13-GU-SAA	Sprung euro profile lock furniture for Guardian 51mm centres	SAA (F1)
8565443	AR280/14-SAA	Sprung oval profile lock furniture 48.5mm centres	SAA (F1)
8565450	AR280/15-SAA	Sprung bathroom furniture 57mm centres	SAA (F1)

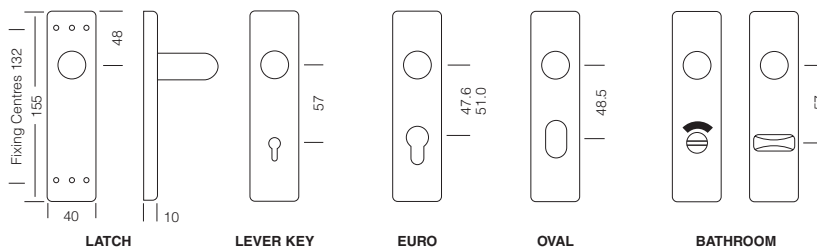

Verona Series

HOPPE Verona Series – 1510/2600

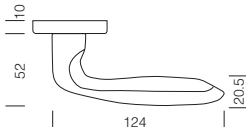

Lever on Concealed Fix Radius Plate (sprung)

features

- Supplied with 8mm x 105mm full profile spindle (630905)
- Supplied complete with bolt through and wood screw fixings – AR200FP (701742)
- Suitable for 41mm to 50mm door thickness
- Longer spindles available for thicker doors: See end of this section
- LRV Rating: HOPPE F1 Finish LRV of 60

standards and certification

 Manufactured by an ISO 9000 Registered Company

ID NO	PRODUCT REF	DESCRIPTION	FINISH
8565457	AR280/31-SAA	Sprung long plate latch furniture	SAA (F1)
8565464	AR280/32-SAA	Sprung lock furniture 57mm centres	SAA (F1)
8565471	AR280/33-SAA	Sprung euro profile lock furniture 47.6mm centres	SAA (F1)
8565485	AR280/34-SAA	Sprung oval profile lock furniture 48.5mm centres	SAA (F1)
8565492	AR280/35-SAA	Sprung bathroom furniture 57mm centres	SAA (F1)

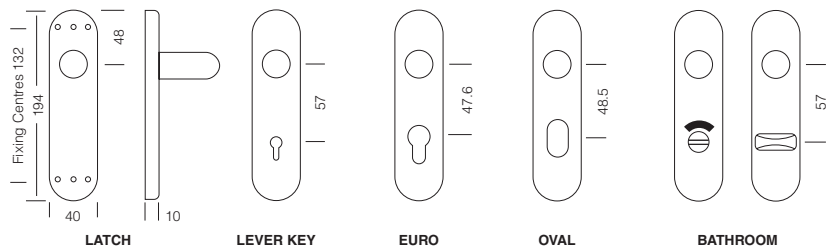

HOPPE Verona Series – 1510/2600

Lever on 160mm x 64mm Face Fix Plate (unsprung)

features

- Supplied with 8mm x 100mm split profile spindle (fixed one side)
- Suitable for 43mm to 57mm door thickness
- Longer spindles available for thicker doors: See end of this section
- Supplied with wood screws
- LRV Rating: HOPPE F1 Finish LRV of 60

standards and certification

 Manufactured by an ISO 9000 Registered Company

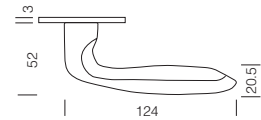

ID NO	PRODUCT REF	DESCRIPTION	FINISH
8565499	AR280/21-UN-SAA	Unsprung long plate latch furniture	SAA (F1)
8565506	AR280/22-UN-SAA	Unsprung lock furniture 57mm centres	SAA (F1)
8565513	AR280/23-UN-SAA	Unsprung euro profile lock furniture 47.6mm centres	SAA (F1)
8565520	AR280/24-UN-SAA	Unsprung oval profile lock furniture 48.5mm centres	SAA (F1)
8565527	AR280/25-UN-SAA	Unsprung bathroom furniture 57mm centres	SAA (F1)

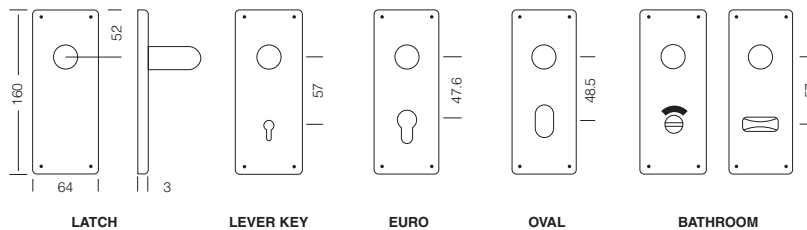

Verona Series

HOPPE Verona Series – 1510/304L



Lever on 160mm x 160mm Face Fix Plate (unsprung)

features

- Supplied with 8mm x 100mm split profile spindle (fixed one side)
- Suitable for 43mm to 57mm door thickness
- Longer spindles available for thicker doors: See end of this section
- Supplied with wood screws
- LRV Rating: HOPPE F1 Finish LRV of 60

standards and certification

 Manufactured by an ISO 9000 Registered Company

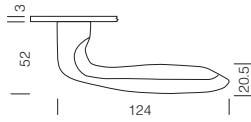

ID NO	PRODUCT REF	DESCRIPTION	FINISH
8565534	AR280/16-UN-SAA	Unsprung long plate latch furniture	SAA (F1)
8565541	AR280/17-UN-SAA	Unsprung lock furniture 57mm centres	SAA (F1)
8565548	AR280/18-UN-SAA	Unsprung euro profile lock furniture 47.6mm centres	SAA (F1)
8565555	AR280/19-UN-SAA	Unsprung oval profile lock furniture 48.5mm centres	SAA (F1)
8565569	AR280/20-UN-LH-SAA	Unsprung bathroom furniture 57mm centres (left hand)	SAA (F1)
8565562	AR280/20-UN-RH-SAA	Unsprung bathroom furniture 57mm centres (right hand)	SAA (F1)

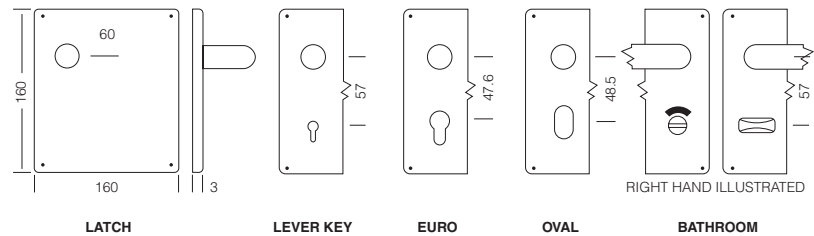



Luxembourg Series



Luxembourg Series

HOPPE Luxembourg Series – 199/42K

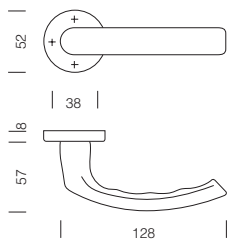

Lever on Round Rose (Sprung)

features

- Supplied with both bolt through and wood screw fixings – AR200FP (701742)
- Supplied with HOPPE 8mm x 105mm full profile spindle (630905)
- Suitable for 40mm to 47mm door thickness
- Longer spindles available for thicker doors: See end of this section
- Nylon understructure – 4 point fixing
- LRV Rating: HOPPE F1 Finish LRV of 60

standards and certification



Quality & Performance: Successfully type tested to all the requirements of BS EN1906: 2002 Grade 3 (Test reports/certificates are available on request)

3	7	-	1*	1	4	0	A
---	---	---	----	---	---	---	---



Fire Safety: Included on a successful fire test to BS EN1634 Part1: 2002. Assessed for use on 30 min, & 1 hour fire doors.



Manufactured by an ISO 9000 Registered Company

ID NO	PRODUCT REF	DESCRIPTION	FINISH
1737899	AR299/10-SAA	Sprung lever on round rose	SAA (F1)

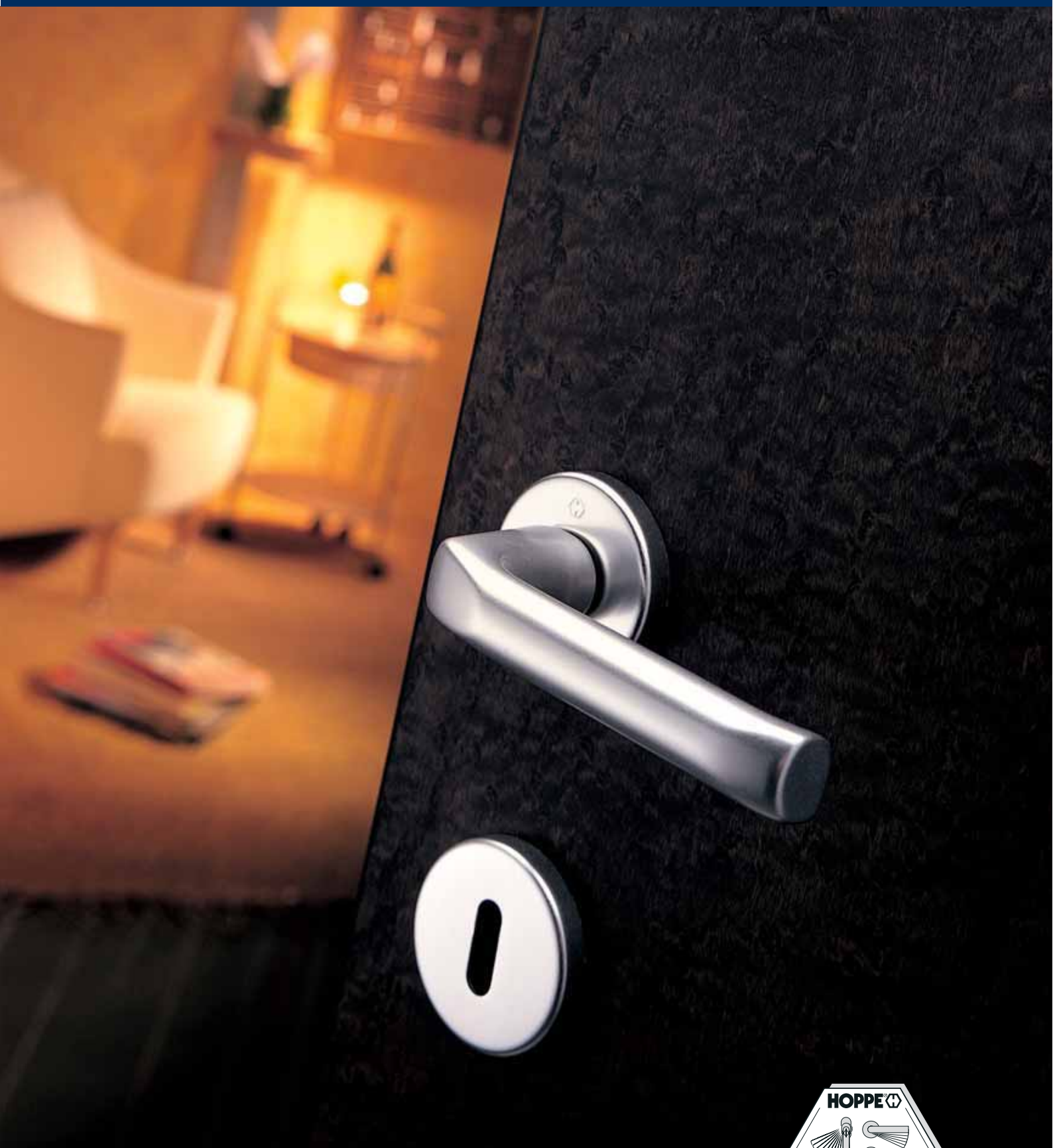

London Series



HOPPE 
10-year
operational
guarantee

London Series

HOPPE London Series – 113/42K

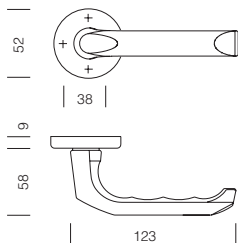

Lever on Round Rose (Sprung)

features

- Supplied with both bolt through fixings
- Supplied with HOPPE 100mm patented split profile spindle (517572)
- Nylon understructure – 4 point fixing
- Suitable for 40mm to 47mm door thickness
- Longer spindles available for thicker doors: See end of this section
- LRV Rating: HOPPE F1 Finish LRV of 60

standards and certification



Manufactured by an ISO 9000 Registered Company



Fire Safety: Included on a successful fire test to BS EN1634 Part1: 2002. Assessed for use on 30 min, & 1 hour fire doors.

ID NO	PRODUCT REF	DESCRIPTION	FINISH
835133	AR170/10-SP-SAA	Sprung lever on round rose	SAA (F1)



Designer Aluminium



HOPPE Tôykô Series – 1710/42K

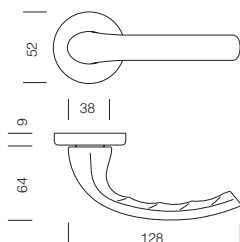

Lever on Round Rose (Unsprung)

features

- Supplied with wood screw fixings
- Supplied with 8mm x 100mm split profile spindle (fixed one side)
- Suitable for 37mm to 42mm door thickness
- Longer spindles available for thicker doors: See end of this section
- LRV Rating: HOPPE F1 Finish LRV of 60

standards and certification



Manufactured by an ISO 9000 Registered Company



Fire Safety: Included on a successful fire test to BS EN1634 Part1: 2002. Assessed for use on 30 min, & 1 hour fire doors.

ID NO	PRODUCT REF	DESCRIPTION	FINISH
1826808	1710/42K-F1	Unsprung lever on round rose	SAA (F1)

HOPPE Amsterdam Series – 1400/42K



SAA (F1)



F1/F69

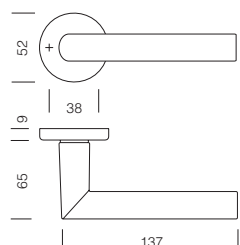

Lever on Round Rose (Unsprung)

features

- Supplied with wood screw fixings
- Supplied with 8mm x 100mm split profile spindle
- Suitable for 30mm to 49mm door thickness
- Longer spindles available for thicker doors: See end of this section
- LRV Rating: HOPPE F1 Finish LRV of 60, HOPPE F69 Finish LRV of 42.63

standards and certification



Manufactured by an ISO 9000 Registered Company



Fire Safety: Included on a successful fire test to BS EN1634 Part1: 2002. Assessed for use on 30 min, & 1 hour fire doors.

ID NO	PRODUCT REF	DESCRIPTION	FINISH
1865276	1400/42K-F1	Unsprung lever on round rose	SAA (F1)
2069511	1400/42K-F1/F69	Unsprung lever on round rose	F1/F69

HOPPE Vitória Series - 1515/42K

Lever on Round Rose (Sprung)

features

- Supplied with wood screw fixings
- Supplied with 8mm x 100mm split profile spindle
- Suitable for 20mm to 49mm door thickness
- Longer spindles available for thicker doors: See end of this section
- LRV Rating: HOPPE F1 Finish LRV of 60

standards and certification

 Manufactured by an ISO 9000 Registered Company

 **Fire Safety:** Included on a successful fire test to BS EN1634 Part1: 2002. Assessed for use on 30 min, & 1 hour fire doors.

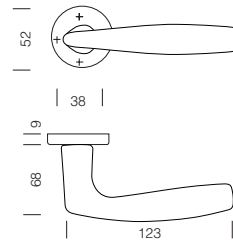

ID NO	PRODUCT REF	DESCRIPTION	FINISH
2526639	1515/42K-F1	Sprung lever on round rose	SAA (F1)

HOPPE Stockholm Series - 1140/42K

Lever on Round Rose (Sprung)

features

- Supplied with wood screw fixings
- Supplied with 8mm x 100mm split profile spindle
- Suitable for 34mm to 49mm door thickness
- Longer spindles available for thicker doors: See end of this section
- LRV Rating: HOPPE F1 Finish LRV of 60

standards and certification

 Manufactured by an ISO 9000 Registered Company

 **Fire Safety:** Included on a successful fire test to BS EN1634 Part1: 2002. Assessed for use on 30 min, & 1 hour fire doors.

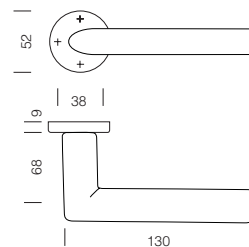

ID NO	PRODUCT REF	DESCRIPTION	FINISH
2503787	1140/42K-F1	Sprung lever on round rose	SAA (F1)

HOPPE Bedford Series - 114L/42K

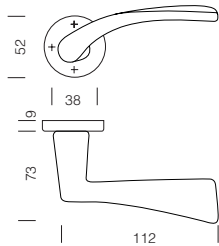

Lever on Round Rose (Sprung)

features

- Supplied with wood screw fixings
- Supplied with 8mm x 100mm split profile spindle (fixed one side)
- Suitable for 30mm to 49mm door thickness
- LRV Rating: HOPPE F1 Finish LRV of 60

standards and certification



Manufactured by an ISO 9000 Registered Company



Fire Safety: Included on a successful fire test to BS EN1634 Part1: 2002. Assessed for use on 30 min, & 1 hour fire doors.

ID NO	PRODUCT REF	DESCRIPTION	FINISH
2663537	114L/42K-F1	Sprung lever on round rose	SAA (F1)



Domestic Aluminium



Domestic Aluminium

HOPPE Edinburgh Series - 189N/266U & 189N/267U



Lever on Concealed Fix Rectangular Plate (Sprung)

features

- Supplied with bolt through fixings - AR200FP (701742)
- Supplied with 8mm x 100mm solid spindle (519156)
- Suitable for 41mm to 50mm door thickness
- LRV Rating: HOPPE F1 Finish LRV of 60, HOPPE F3 Finish LRV of 43.55

standards and certification

 Manufactured by an ISO 9000 Registered Company

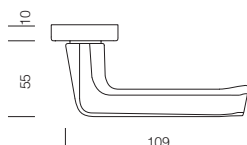

ID NO	PRODUCT REF	DESCRIPTION	FINISH
529889	AR157-SAA	Sprung short plate latch furniture	SAA (F1)
569151	AR158/11-SAA	Sprung long plate latch furniture	SAA (F1)
1920677	AR158/11-GAA	Sprung long plate latch furniture	GAA (F3)
529933	AR158/12-SAA	Sprung lock furniture 57mm centres	SAA (F1)
771509	AR158/12-GAA	Sprung lock furniture 57mm centres	GAA (F3)
569144	AR158/13-SAA	Sprung euro profile lock furniture 47.6mm centres	SAA (F1)
797196	AR158/13-GAA	Sprung euro profile lock furniture 47.6mm centres	GAA (F3)
799398	AR158/13-GU-SAA	Sprung euro profile lock furniture for Guardian 51mm centres	SAA (F1)
630332	AR158/14-SAA	Sprung oval profile lock furniture 48.5mm centres	SAA (F1)
797202	AR158/14-GAA	Sprung oval profile lock furniture 48.5mm centres	GAA (F3)
630349	AR158/15-SAA	Sprung bathroom furniture 57mm centres	SAA (F1)
1988090	AR158/15-GAA	Sprung bathroom furniture 57mm centres	GAA (F3)

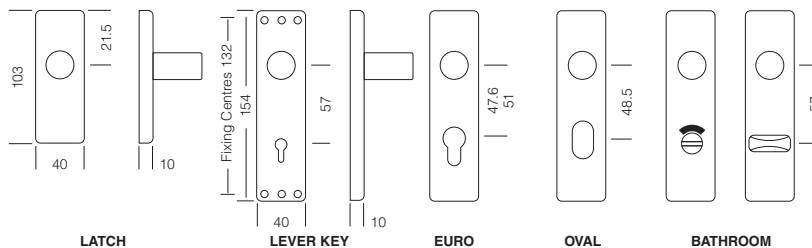

HOPPE Edinburgh Series - 189N/266V & 189N/267

Lever on Face Fix Rectangular Plate (Sprung)

features

- Supplied with wood screws
- Supplied with 8mm x 100mm solid spindle (519156)
- Suitable for 20mm to 40mm door thickness
- LRV Rating: HOPPE F1 Finish LRV of 60

standards and certification

 Manufactured by an ISO 9000 Registered Company

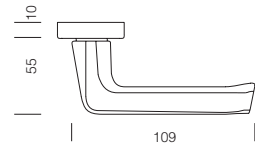

ID NO	PRODUCT REF	DESCRIPTION	FINISH
1737784	189N/266-UG-SAA	Sprung short plate latch furniture	SAA (F1)
1737792	189N/267-EP57-SAA	Sprung lock furniture 57mm centres	SAA (F1)
683185	189N/267-PZ47.6-SAA	Sprung euro profile lock furniture 47.6mm centres	SAA (F1)
1737805	189N/267-OZ48.5-SAA	Sprung oval profile lock furniture 48.5mm centres	SAA (F1)
1737813	189N/267-RW-SK/OL57-SAA	Sprung bathroom furniture 57mm centres	SAA (F1)

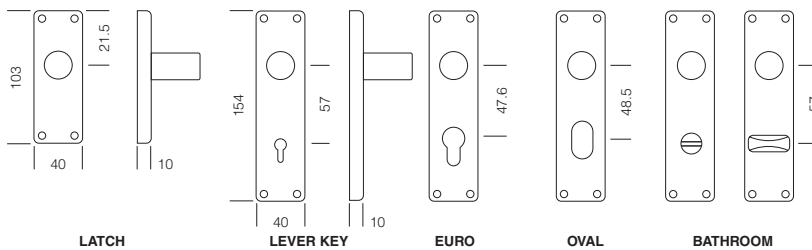

HOPPE Dubayy Series - 107L/266V & 107L/267

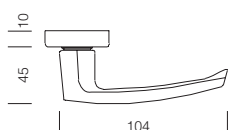

Lever on Face Fix Rectangular Plate (Sprung)

features

- Supplied with wood screw fixings
- Supplied with 8mm x 100mm solid spindle (519156)
- Suitable for 20mm to 40mm door thickness
- LRV Rating: HOPPE F1 Finish LRV of 60, HOPPE F3 Finish LRV of 43.55

standards and certification

- ✓ **Quality & Performance:** Successfully type tested to all the requirements of BS EN1906: 2002 Grade 2 (Test reports/certificates are available on request)

*Note: this classification only applies to the product marked with an asterisk

2	6	-	0	1	3	0	A
---	---	---	---	---	---	---	---

- ISO Manufactured by an ISO 9000 Registered Company

ID NO	PRODUCT REF	DESCRIPTION	FINISH
1735092	AR103-SAA*	Sprung short plate latch furniture	SAA (F1)
1735201	AR104-SAA*	Sprung lock furniture 57mm centres	SAA (F1)
1735236	AR104-GAA*	Sprung lock furniture 57mm centres	GAA (F3)
1735295	AR104-P-SAA	Sprung euro profile lock furniture 47.6mm centres	SAA (F1)
1735279	AR104-U-SAA	Sprung oval profile lock furniture 48.5mm centres	SAA (F1)
1737750	AR105-SAA	Sprung bathroom furniture 57mm centres (no indicator)	SAA (F1)
1737776	AR105-GAA	Sprung bathroom furniture 57mm centres (no indicator)	GAA (F3)

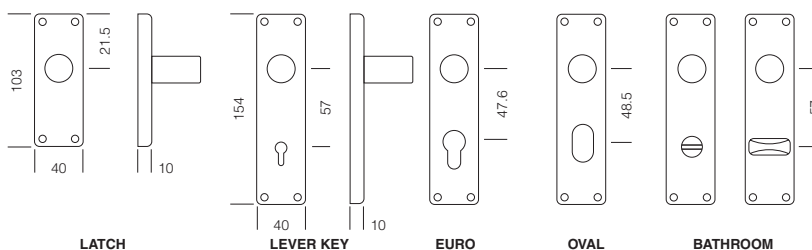

HOPPE Dubayy Series - 107L/2835K

Lever on Face Fix Rectangular Extruded Plate Nylon Insets (Sprung)

features

- Supplied with wood screw fixings
- Supplied with 8mm x 100mm solid spindle (519156)
- Suitable for 32mm to 50mm door thickness
- LRV Rating: HOPPE F1 Finish LRV of 60

standards and certification

 Manufactured by an ISO 9000 Registered Company

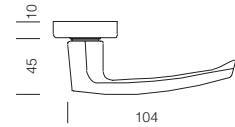

ID NO	PRODUCT REF	DESCRIPTION	FINISH
2289987	107L/2835K-UG-SAA	Sprung short plate latch furniture	SAA (F1)
2290048	107L/2835K-EP57-SAA	Sprung lock furniture 57mm centres	SAA (F1)
2290030	107L/2835K-PZ47.6-SAA	Sprung euro profile lock furniture 47.6mm centres	SAA (F1)
2290021	107L/2835K-SK/OL57-SAA	Sprung bathroom furniture 57mm centres (no indicator)	SAA (F1)

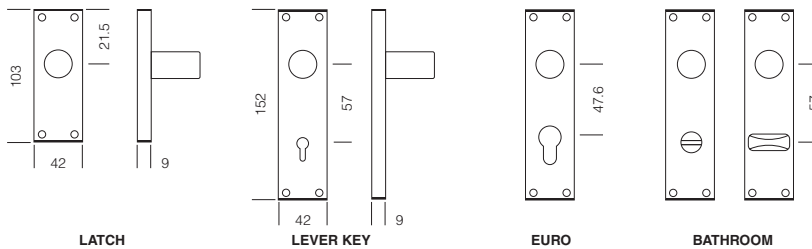





Special Application Lever Furniture

Special Application Lever Furniture

Special Application Lever Furniture

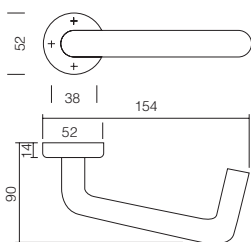

ARRONE® Lever on Round Rose (Sprung)

features

- Suitable for 35mm to 50mm door thickness
- Supplied with wood screw fixings

ID NO	PRODUCT REF	DESCRIPTION	FINISH
8510129	AR750/10-SAA	Sprung lever on round rose	SAA



Disabled Turn and Indicator

ID NO	PRODUCT REF	DESCRIPTION	FINISH
2260631	AR200/29D-H-SAA	Disabled turn and indicator	SAA (F1)
8510185	AR750/29-SAA	Disabled turn and indicator	SAA

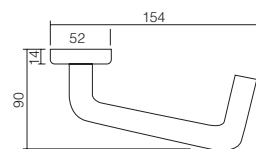
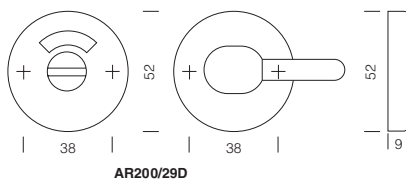

ARRONE® Lever on Concealed Fix Rectangular Plate (Sprung)

features

- Suitable for 35mm to 50mm door thickness
- Supplied with wood screw fixings
- Sprung lever

ID NO	PRODUCT REF	DESCRIPTION	FINISH
8510136	AR750/11-SAA	Sprung long plate latch furniture	SAA
8510143	AR750/12-SAA	Sprung lock furniture 57mm centres	SAA
8510150	AR750/13-SAA	Sprung euro profile lock furniture 47.6mm centres	SAA
8510157	AR750/14-SAA	Sprung oval profile lock furniture 48.5mm centres	SAA
8510164	AR750/15-SAA	Sprung bathroom furniture 57mm centres (large turn)	SAA

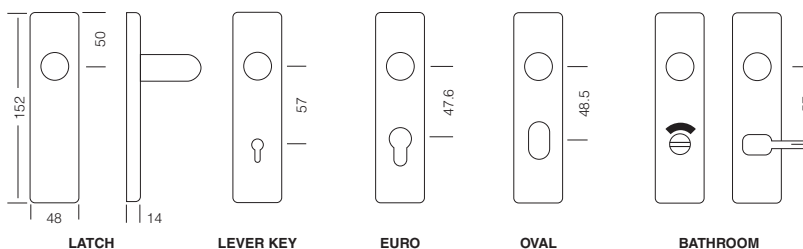



Escutcheons,
Indicators & Turns

Escutcheons, Indicators & Turns

HOPPE Escutcheons



Concealed Fixing Ø 52mm with 38mm fixing centres

features

- 2 point screw fixing
- Nylon internal rose
- LRV Rating: HOPPE F1 Finish LRV of 60, HOPPE F3 Finish LRV of 43.55

ID NO	PRODUCT REF	DESCRIPTION	FINISH
762804	AR200/26-SAA	Lever key escutcheon (pair)	SAA (F1)
762750	AR200/27-SAA	Euro profile escutcheon (pair)	SAA (F1)
1687334	AR200/28-SAA	Oval profile escutcheon (pair)	SAA (F1)
762934	AR200/30-SAA	Blank escutcheon (pair)	SAA (F1)
811045	AR200/26-GAA	Lever key escutcheon (pair)	GAA (F3)
812103	AR200/27-GAA	Euro profile escutcheon (pair)	GAA (F3)
832798	AR200/28-GAA	Oval profile escutcheon (pair)	GAA (F3)
827206	AR200/30-GAA	Blank escutcheon (pair)	GAA (F3)

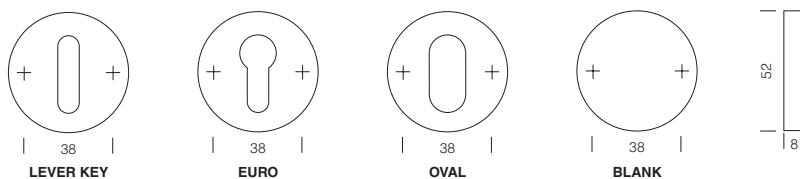

HOPPE Bathroom Turns & Indicators/Releases

Concealed Fixing Ø 52mm with 38mm fixing centres

features

- 5mm spindle
- 2 point screw fixing
- Nylon internal rose
- LRV Rating: HOPPE F1 Finish LRV of 60, HOPPE F3 Finish LRV of 43.55



ID NO	PRODUCT REF	DESCRIPTION	FINISH
1804422	AR200/29-SAA	Bathroom turn and indicator	SAA (F1)
812523	AR200/29-GAA	Bathroom turn and indicator	GAA (F3)
1515527	AR-6/7/8-SLEEVE	Spindle sleeve pack – to adapt 5mm spindle to 6, 7 or 8mm	

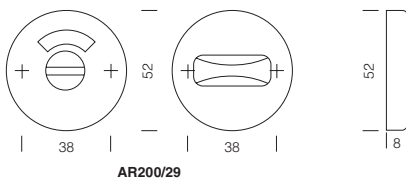

Disabled Bathroom Turn (5mm Spindle)

ID NO	PRODUCT REF	DESCRIPTION	FINISH
2260631	AR200/29D-H-SAA	Disabled bathroom turn and indicator	SAA (F1)
1515527	AR-6/7/8-SLEEVE	Spindle sleeve pack – to adapt 5mm spindle to 6, 7 or 8mm	

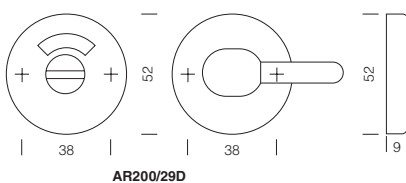

ARRONE[®] Face Fixing Escutcheons

ID NO	PRODUCT REF	DESCRIPTION	FINISH
8500833	AR162-SAA	Ø 32mm lever key escutcheon (single)	SAA
8500847	AR163-SAA	Ø 32mm lever key covered escutcheon (single)	SAA
8500854	AR164-SAA	Ø 50mm lever key escutcheon (single)	SAA
8500861	AR164U-SAA	Ø 50mm oval profile cylinder escutcheon (single)	SAA
8500868	AR164YP-SAA	Ø 50mm euro cylinder escutcheon (single)	SAA







Architectural Pull Handles

Architectural Pull Handles

HOPPE Pull Handles



Straight Pull Handles ('D' Handles) Concealed Screw Fixing Ø 20mm – HOPPE Ref. 5040

features

- Supplied with Concealed Screw Fixing Pack (605422)
- LRV Rating: HOPPE F1 Finish LRV of 60

standards and certification



Conformity Statement: Pull Handles with a length of 400mm and above meet the dimensional recommendations of BS8300 and Approved Document "M"

ID NO	PRODUCT REF	DESCRIPTION	FINISH
1722443	AR202/H/150CF-SAA	20mm x 150mm concealed screw fixing pull handle	SAA (F1)
1722460	AR202/H/225CF-SAA	20mm x 225mm concealed screw fixing pull handle	SAA (F1)
1722486	AR202/H/300CF-SAA	20mm x 300mm concealed screw fixing pull handle	SAA (F1)
1722494	AR202/H/425CF-SAA	20mm x 425mm concealed screw fixing pull handle	SAA (F1)

Straight Pull Handles ('D' Handles) Concealed Screw Fixing Ø 22mm – HOPPE Ref. 5040

features

- Supplied with Concealed Screw Fixing Pack (605422)
- LRV Rating: HOPPE F1 Finish LRV of 60

standards and certification



Conformity Statement: Pull Handles with a length of 400mm and above meet the dimensional recommendations of BS8300 and Approved Document "M"

ID NO	PRODUCT REF	DESCRIPTION	FINISH
8563406	AR222/H/225CF-SAA	22mm x 225mm concealed screw fixing pull handle	SAA (F1)
1722558	AR222/H/300CF-SAA	22mm x 300mm concealed screw fixing pull handle	SAA (F1)
1722582	AR222/H/425CF-SAA	22mm x 425mm concealed screw fixing pull handle	SAA (F1)

HOPPE Pull Handles

Straight Pull Handles ('D' Handles) Bolt Through Fixing Ø 20mm HOPPE Ref. 5040

features

- Suitable for 39mm to 49mm door thickness
- Supplied with Bolt Through Fixing Pack (606122)
- Can be supplied with Concealed Fixing Pack (605422)
- LRV Rating: HOPPE F1 Finish LRV of 60

standards and certification

 **Conformity Statement:** Pull Handles with a length of 400mm and above meet the dimensional recommendations of BS8300 and Approved Document "M"

ID NO	PRODUCT REF	DESCRIPTION	FINISH
1722451	AR203/H/150BF-SAA	20mm x 150mm bolt through fixing pull handle	SAA (F1)
1722478	AR203/H/225BF-SAA	20mm x 225mm bolt through fixing pull handle	SAA (F1)
8561908	AR203/H/300BF-SAA	20mm x 300mm bolt through fixing pull handle	SAA (F1)
1722507	AR203/H/425BF-SAA	20mm x 425mm bolt through fixing pull handle	SAA (F1)

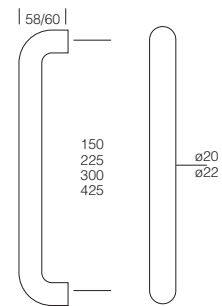

Straight Pull Handles ('D' Handles) Bolt Through Fixing Ø 22mm HOPPE Ref. 5040

features

- Suitable for 39mm to 49mm door thickness
- Supplied with Bolt Through Fixing Pack (606122)
- Can be supplied with Concealed Fixing Pack (605422)
- LRV Rating: HOPPE F1 Finish LRV of 60

standards and certification

 **Conformity Statement:** Pull Handles with a length of 400mm and above meet the dimensional recommendations of BS8300 and Approved Document "M"

ID NO	PRODUCT REF	DESCRIPTION	FINISH
1722531	AR223/H/225BF-SAA	22mm x 225mm bolt through fixing pull handle	SAA (F1)
1722566	AR223/H/300BF-SAA	22mm x 300mm bolt through fixing pull handle	SAA (F1)
1722591	AR223/H/425BF-SAA	22mm x 425mm bolt through fixing pull handle	SAA (F1)

Architectural Pull Handles

HOPPE Pull Handles



Straight Pull Handles ('D' Handles) Bolt Through Fixing Ø 25mm
HOPPE Ref. 5000

features

- Supplied with Bolt Through Fixing Pack (618668)
- LRV Rating: HOPPE F1 Finish LRV of 60

ID NO	PRODUCT REF	DESCRIPTION	FINISH
1722620	AR203/25/300BF-SAA	25mm x 300mm bolt through fixing pull handle	SAA (F1)
1722603	AR203/25/350BF-SAA	25mm x 350mm bolt through fixing pull handle	SAA (F1)

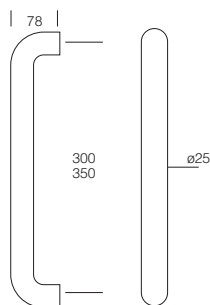

HOPPE Pull Handles

Straight Pull Handles ('D' Handles) Back-to-Back Fixing Ø 20mm HOPPE Ref. 5040

features

- Suitable for 38mm to 48mm door thickness
- Supplied with Back-to-Back Fixing Pack (592494)
- Can be supplied with 2 sets of Concealed Fixing Packs (605422)
- LRV Rating: HOPPE F1 Finish LRV of 60

standards and certification

 **Conformity Statement:** Pull Handles with a length of 400mm and above meet the dimensional recommendations of BS8300 and Approved Document "M"

ID NO	PRODUCT REF	DESCRIPTION	FINISH
8561915	AR204/H/150BB-SAA	20mm x 150mm back-to-back fixing pull handle	SAA (F1)
1722401	AR204/H/225BB-SAA	20mm x 225mm back-to-back fixing pull handle	SAA (F1)
1722435	AR204/H/300BB-SAA	20mm x 300mm back-to-back fixing pull handle	SAA (F1)
1748740	AR204/H/425BB-SAA	20mm x 425mm back-to-back fixing pull handle	SAA (F1)

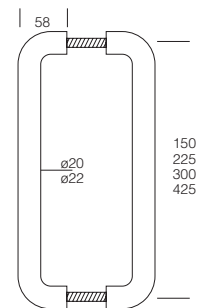

Straight Pull Handles ('D' Handles) Back-to-Back Fixing Ø 22mm HOPPE Ref. 5060

features

- Supplied with Back-to-Back Fixing Pack (592494)
- Can be supplied with 2 sets of Concealed Fixing Packs (1668281)
- LRV Rating: HOPPE F1 Finish LRV of 60

standards and certification

 **Conformity Statement:** Pull Handles with a length of 400mm and above meet the dimensional recommendations of BS8300 and Approved Document "M"

ID NO	PRODUCT REF	DESCRIPTION	FINISH
8563700	AR224/H/150BB-SAA	22mm x 150mm back-to-back fixing pull handle	SAA (F1)
1722540	AR224/H/225BB-SAA	22mm x 225mm back-to-back fixing pull handle	SAA (F1)
1722574	AR224/H/300BB-SAA	22mm x 300mm back-to-back fixing pull handle	SAA (F1)
8563707	AR224/H/425BB-SAA	22mm x 425mm back-to-back fixing pull handle	SAA (F1)

Straight Pull Handles ('D' Handles) Back-to-Back Fixing Ø 25mm HOPPE Ref. 5000

features

- Supplied with two Back-to-Back Fixing Bolts (600168)
- LRV Rating: HOPPE F1 Finish LRV of 60

ID NO	PRODUCT REF	DESCRIPTION	FINISH
1722611	AR204/25/300BB-SAA	25mm x 300mm back-to-back fixing pull handle	SAA (F1)
8561404	AR204/25/350BB-SAA	25mm x 350mm back-to-back fixing pull handle	SAA (F1)

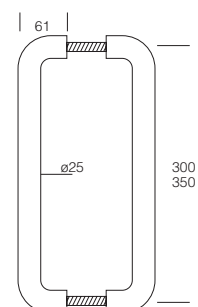

Architectural Pull Handles

HOPPE Pull Handles

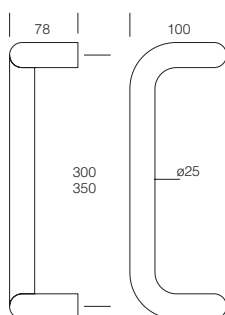

Cranked Pull Handles Bolt Through Fixing Ø 25mm HOPPE Ref. 5110

features

- Suitable for 39mm to 49mm door thickness
- Supplied with Bolt Through Fixing Pack (618668)
- LRV Rating: HOPPE F1 Finish LRV of 60

ID NO	PRODUCT REF	DESCRIPTION	FINISH
8561376	AR241/25/300BF-SAA	25mm x 300mm bolt through fixing pull handle	SAA (F1)
8561362	AR241/25/350BF-SAA	25mm x 350mm bolt through fixing pull handle	SAA (F1)

Cranked Pull Handles Back-to-Back Fixing Ø 25mm HOPPE Ref. 5110

features

- Suitable for 38mm to 48mm door thickness
- Supplied with two Back-to-Back Fixing Bolts (600168)
- LRV Rating: HOPPE F1 Finish LRV of 60

ID NO	PRODUCT REF	DESCRIPTION	FINISH
8561369	AR241/25/300BB-SAA	25mm x 300mm back-to-back fixing pull handle	SAA (F1)
8561355	AR241/25/350BB-SAA	25mm x 350mm back-to-back fixing pull handle	SAA (F1)



ARRONE[®] Pull Handles

ARRONE® Pull Handles

ARRONE® Pull Handles

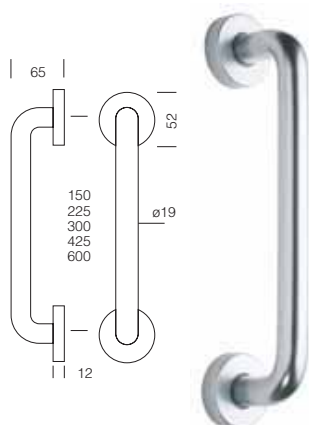

Straight Pull Handles ('D' Handles) Concealed Screw Fixing: Ø 19mm

standards and certification

 **Conformity Statement:** Pull Handles with a length of 400mm and above meet the dimensional recommendations of BS8300 and Approved Document "M"

ID NO	PRODUCT REF	DESCRIPTION	FINISH
8504193	AR202/150CF-SAA	19mm x 150mm concealed screw fixing pull handle	SAA
8504200	AR202/225CF-SAA	19mm x 225mm concealed screw fixing pull handle	SAA
8504207	AR202/300CF-SAA	19mm x 300mm concealed screw fixing pull handle	SAA
8504214	AR202/425CF-SAA	19mm x 425mm concealed screw fixing pull handle	SAA
87107110	AR202/600CF-SAA	19mm x 600mm concealed screw fixing pull handle	SAA

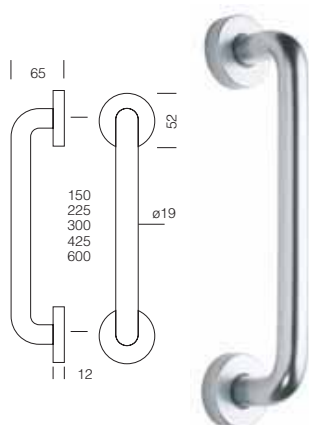

Straight Pull Handles ('D' Handles) Dual Function Concealed/ Bolt Fix: Ø 19mm

features

- Supplied complete with concealed screw fixings & roses and bolt fixings.

standards and certification

 **Conformity Statement:** Pull Handles with a length of 400mm and above meet the dimensional recommendations of BS8300 and Approved Document "M"

ID NO	PRODUCT REF	DESCRIPTION	FINISH
87105920	AR2023/150CF/BF-SAA	19mm x 150mm concealed screw / bolt fixed pull handle	SAA
87105921	AR2023/225CF/BF-SAA	19mm x 225mm concealed screw / bolt fixed pull handle	SAA
87105922	AR2023/300CF/BF-SAA	19mm x 300mm concealed screw / bolt fixed pull handle	SAA
87105923	AR2023/425CF/BF-SAA	19mm x 425mm concealed screw / bolt fixed pull handle	SAA
87107111	AR2023/600CF/BF-SAA	19mm x 600mm concealed screw / bolt fixed pull handle	SAA

ARRONE[®] Pull Handles

Straight Pull Handles ('D' Handles) Bolt Through Fixing: Ø 19mm

standards and certification

-  **Conformity Statement:** Pull Handles with a length of 400mm and above meet the dimensional recommendations of BS8300 and Approved Document "M"

ID NO	PRODUCT REF	DESCRIPTION	FINISH
8504221	AR203/150BF-SAA	19mm x 150mm bolt through fixing pull handle	SAA
8504228	AR203/225BF-SAA	19mm x 225mm bolt through fixing pull handle	SAA
8504242	AR203/300BF-SAA	19mm x 300mm bolt through fixing pull handle	SAA
8504249	AR203/425BF-SAA	19mm x 425mm bolt through fixing pull handle	SAA
87107112	AR203/600BF-SAA	19mm x 600mm bolt through fixing pull handle	SAA

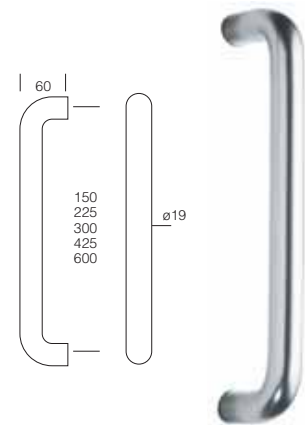

Straight Pull Handles ('D' Handles) Back-to-Back Fixing: Ø 19mm

features

- These pull handles are supplied with sleeve and washers for glass doors, which must be removed when used on timber doors

standards and certification

-  **Conformity Statement:** Pull Handles with a length of 400mm and above meet the dimensional recommendations of BS8300 and Approved Document "M"

ID NO	PRODUCT REF	DESCRIPTION	FINISH
8504256	AR204/150BB-SAA	19mm x 150mm back-to-back fixing pull handle	SAA
8504263	AR204/225BB-SAA	19mm x 225mm back-to-back fixing pull handle	SAA
8504270	AR204/300BB-SAA	19mm x 300mm back-to-back fixing pull handle	SAA
87107113	AR204/425BB-SAA	19mm x 425mm back-to-back fixing pull handle	SAA
87107114	AR204/600BB-SAA	19mm x 600mm back-to-back fixing pull handle	SAA

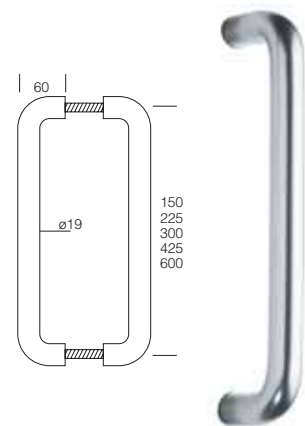

ARRONE® Pull Handles

ARRONE® Pull Handles

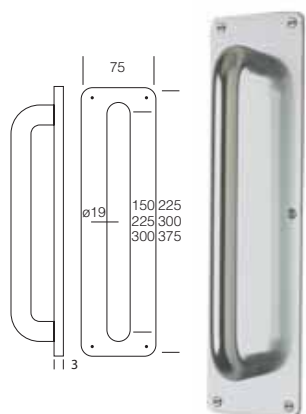

Straight Pull Handles ('D' Handles) Screw Fix on Plate Ø 19mm

ID NO	PRODUCT REF	DESCRIPTION	FINISH
8504277	AR205/150FF-P-SAA	19mm x 150mm screw fix pull handle on plate	SAA
8504284	AR205/225FF-P-SAA	19mm x 225mm screw fix pull handle on plate	SAA
8504291	AR205/300FF-P-SAA	19mm x 300mm screw fix pull handle on plate	SAA

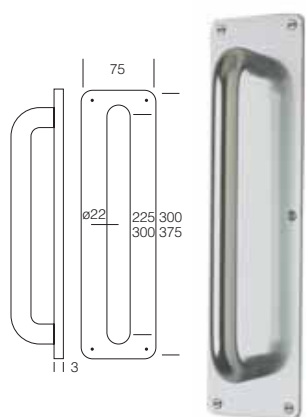

Straight Pull Handles ('D' Handles) Screw Fix on Plate Ø 22mm

ID NO	PRODUCT REF	DESCRIPTION	FINISH
8504641	AR225/225FF-P-SAA	22mm x 225mm screw fix pull handle on plate	SAA
8504648	AR225/300FF-P-SAA	22mm x 300mm screw fix pull handle on plate	SAA

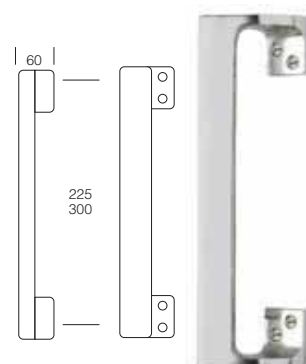

Cranked Pull Handles

ID NO	PRODUCT REF	DESCRIPTION	FINISH
8500315	AR106A-SAA	225mm cranked pull handle	SAA
8500322	AR106B-SAA	300mm cranked pull handle	SAA



Architectural Accessories

Architectural Accessories

ARRONE® Architectural Accessories



ID NO	PRODUCT REF	DESCRIPTION	FINISH
8504340	AR207M-SAA	155mm square male sign	SAA
8504333	AR207F-SAA	155mm square female sign	SAA
8504347	AR207U-SAA	155mm square unisex sign	SAA
8504326	AR207D-SAA	155mm square disabled sign	SAA



ID NO	PRODUCT REF	DESCRIPTION	FINISH
8511557	AR908M-SAA	100mm x 150mm rectangular male sign	SAA
8511529	AR908F-SAA	100mm x 150mm rectangular female sign	SAA
8511501	AR908D-SAA	100mm x 150mm rectangular disabled sign	SAA



ID NO	PRODUCT REF	DESCRIPTION	FINISH
8511361	AR903M-SAA	Ø 76mm circular male sign	SAA
8511333	AR903F-SAA	Ø 76mm circular female sign	SAA
87100544	AR903U-SAA	Ø 76mm circular unisex sign	SAA
8511305	AR903D-SAA	Ø 76mm circular disabled sign	SAA



ID NO	PRODUCT REF	DESCRIPTION	FINISH
8511214	AR900-SAA	Ø 76mm "Keep locked shut" sign	SAA
8511242	AR901-SAA	Ø 76mm "Fire door keep locked" sign	SAA
8511277	AR902-SAA	Ø 76mm "Fire door keep shut" sign	SAA



ID NO	PRODUCT REF	DESCRIPTION	FINISH
8511389	AR904-SAA	80mm square "Keep locked shut" sign	SAA
8511417	AR905-SAA	80mm square "Fire door keep shut" sign	SAA
8511445	AR906-SAA	80mm square "Fire door keep locked" sign	SAA
8511473	AR907-SAA	80mm square "Fire door keep locked shut" sign	SAA



ID NO	PRODUCT REF	DESCRIPTION	FINISH
8504298	AR206P-SAA	Cylinder Pull – plain (no hole)	SAA
8504305	AR206S-SAA	Cylinder Pull for standard rim cylinder	SAA
8504319	AR206YP-SAA	Cylinder Pull for euro profile cylinder	SAA
8504312	AR206U-SAA	Cylinder Pull for oval profile cylinder	SAA



ID NO	PRODUCT REF	DESCRIPTION	FINISH
8504389	AR210A-SAA	150mm surface door bolt	SAA
8504396	AR210B-SAA	200mm surface door bolt	SAA

ARRONE[®] Architectural Accessories

ID NO	PRODUCT REF	DESCRIPTION	FINISH
8504354	AR208A-SAA	305mm x 100mm (aperture 250mm x 50mm) sprung letter plate	SAA
8504361	AR208B-SAA	345mm x 128mm (aperture 297mm x 76mm) sprung letter plate	SAA
8504368	AR208C-SAA	405mm x 128mm (aperture 347mm x 76mm) sprung letter plate	SAA



ID NO	PRODUCT REF	DESCRIPTION	FINISH
8504410	AR213-SAA	70mm projection, wall or skirting door stop (secret fix)	SAA



ID NO	PRODUCT REF	DESCRIPTION	FINISH
8504424	AR214W-SAA	Wooden floor mounted door stop	SAA



ID NO	PRODUCT REF	DESCRIPTION	FINISH
8504452	AR217-SAA	Hat and coat hook	SAA



ID NO	PRODUCT REF	DESCRIPTION	FINISH
8504459	AR218-SAA	Buffered hat and coat hook	SAA



ID NO	PRODUCT REF	DESCRIPTION	FINISH
8504466	AR219-SAA	Wardrobe hook	SAA



ID NO	PRODUCT REF	DESCRIPTION	FINISH
8504620	AR224A-SAA	75mm x 305mm finger plate (rounded corners)	SAA
8504627	AR224B-SAA	75mm x 305mm finger plate (fully radiused ends)	SAA
8562741	AR224C-SAA	75mm x 350mm finger plate (square corners)	SAA
8562748	AR224D-SAA	75mm x 475mm finger plate (square corners)	SAA



ID NO	PRODUCT REF	DESCRIPTION	FINISH
	AR225	Kicking Plate (cut to order)	SAA & GAA



ID NO	PRODUCT REF	DESCRIPTION	FINISH
8504676	AR227-SAA	63mm projecting handrail bracket	SAA



Architectural Accessories

ARRONE® Contract Accessories



ID NO	PRODUCT REF	DESCRIPTION	FINISH
8500462	AR115-SAA	Contract Cylinder Pull for standard rim cylinder	SAA



ID NO	PRODUCT REF	DESCRIPTION	FINISH
8500448	AR114A-SAA	250mm letter tidy	SAA



ID NO	PRODUCT REF	DESCRIPTION	FINISH
8500609	AR132A-SAA	19mm x 150mm lever action flush bolt	SAA

8500616	AR132B-SAA	19mm x 200mm lever action flush bolt	SAA
---------	-------------------	--------------------------------------	------------



ID NO	PRODUCT REF	DESCRIPTION	FINISH
8500623	AR133A-SAA	50mm straight barrel bolt	SAA

8500630	AR133B-SAA	63mm straight barrel bolt	SAA
---------	-------------------	---------------------------	------------

8500637	AR133C-SAA	75mm straight barrel bolt	SAA
---------	-------------------	---------------------------	------------

8500644	AR133D-SAA	100mm straight barrel bolt	SAA
---------	-------------------	----------------------------	------------

8500651	AR133E-SAA	150mm straight barrel bolt	SAA
---------	-------------------	----------------------------	------------



ID NO	PRODUCT REF	DESCRIPTION	FINISH
8500658	AR134A-SAA	75mm necked barrel bolt	SAA

8500665	AR134B-SAA	100mm necked barrel bolt	SAA
---------	-------------------	--------------------------	------------

8500672	AR134C-SAA	150mm necked barrel bolt	SAA
---------	-------------------	--------------------------	------------



ID NO	PRODUCT REF	DESCRIPTION	FINISH
8500714	AR138-SAA	Indicator bolt	SAA



ID NO	PRODUCT REF	DESCRIPTION	FINISH
8500483	AR122-SAA	Oval shielded door stop	SAA



ID NO	PRODUCT REF	DESCRIPTION	FINISH
8500490	AR123A-SAA	ø25mm shielded door stop	SAA

8500497	AR123B-SAA	ø41mm shielded door stop	SAA
---------	-------------------	--------------------------	------------

ARRONE® Contract Accessories

ID NO	PRODUCT REF	DESCRIPTION	FINISH
8500574	AR130A-SAA	Round rose concealed fixing door stop (63mm projection)	SAA
8500581	AR130B-SAA	Round rose concealed fixing door stop (76mm projection)	SAA



ID NO	PRODUCT REF	DESCRIPTION	FINISH
8500588	AR130C-SAA	Round rose face fixing door stop (63mm projection)	SAA
8500595	AR130D-SAA	Round rose face fixing door stop (76mm projection)	SAA



ID NO	PRODUCT REF	DESCRIPTION	FINISH
8500840	AR162A	Ø 35mm black rubber door stop	SAA



ID NO	PRODUCT REF	DESCRIPTION	FINISH
8500679	AR135A-SAA	89mm strip pattern hat and coat hook	SAA
8500693	AR135B-SAA	125mm strip pattern hat and coat hook	SAA



ID NO	PRODUCT REF	DESCRIPTION	FINISH
8500700	AR136-SAA	89mm hat and coat hook	SAA



ID NO	PRODUCT REF	DESCRIPTION	FINISH
8500707	AR137-SAA	Wardrobe hook	SAA



ID NO	PRODUCT REF	DESCRIPTION	FINISH
8500791	AR146-SAA	75mm x 305mm finger plate (square corners)	SAA



ID NO	PRODUCT REF	DESCRIPTION	FINISH
8500798	AR146-PUSH-SAA	75mm x 305mm finger plate engraved "PUSH" (square corners)	SAA



ID NO	PRODUCT REF	DESCRIPTION	FINISH
8500553	AR129A-SAA	ø25mm cupboard knob	SAA
8500560	AR129B-SAA	ø32mm cupboard knob	SAA
8500567	AR129C-SAA	ø38mm cupboard knob	SAA



Architectural Accessories

ARRONE® Contract Accessories



ID NO	PRODUCT REF	DESCRIPTION	FINISH
8500532	AR127A-SAA	10mm x 102mm cupboard "D" handle	SAA
8500539	AR127B-SAA	10mm x 150mm cupboard "D" handle	SAA
8500546	AR128-SAA	13mm x 150mm cupboard "D" handle	SAA



ID NO	PRODUCT REF	DESCRIPTION	FINISH
8500504	AR124A-SAA	204mm casement stay	SAA
8500511	AR124B-SAA	254mm casement stay	SAA
8500518	AR124C-SAA	305mm casement stay	SAA



ID NO	PRODUCT REF	DESCRIPTION	FINISH
8500525	AR126-SAA	Casement fastener	SAA



ID NO	PRODUCT REF	DESCRIPTION	FINISH
	AR140/X	50mm numeral 0 to 9 c/w drilled and countersunk holes	SAA



ID NO	PRODUCT REF	DESCRIPTION	FINISH
8500602	AR131-SAA	Toilet roll holder	SAA

HOPPE Spare Parts

Spindles

Please note – to fit handles safely and achieve optimum performance please ensure spindles are fitted at least 20 to 25mm into the lever

ID NO	PRODUCT REF	DESCRIPTION
630905	06855-0105-0000	8mm x 105mm full profile spindle to suit up to 44mm door thickness
680092	06855-2589-0000	8mm x 125mm full profile spindle to suit up to 54mm door thickness
821914	06855-2590-0000	8mm x 135mm full profile spindle to suit up to 64mm door thickness



ID NO	PRODUCT REF	DESCRIPTION
517572	06850-2289-0000	8mm x 100mm HOPPE Patented split profile spindle to suit up to 44mm door thickness
517565	06850-2689-0000	8mm x 120mm HOPPE Patented split profile spindle to suit up to 54mm door thickness
672578	06850-3090-0000	8mm x 130mm HOPPE patented split profile spindle to suit up to 64mm door thickness



ID NO	PRODUCT REF	DESCRIPTION
630899	AR229/60	8mm x 60mm half spindle to suit up to 44mm door thickness
515073	AR229/70	8mm x 70mm half spindle to suit up to 54mm door thickness



ID NO	PRODUCT REF	DESCRIPTION
8504683	AR228A	8mm x 100mm spindle for split follower lock to suit up to 44mm door thickness
87107098	AR228B	8mm x 120mm spindle for split follower lock to suit up to 54mm door thickness
87107099	AR228C	8mm x 140mm spindle for split follower lock to suit up to 64mm door thickness



ID NO	PRODUCT REF	DESCRIPTION
630929	07050-1789-0000	5mm x 75mm solid spindle for bathroom and privacy furniture to suit up to 50mm door thickness



Lever Furniture Fixings

ID NO	PRODUCT REF	DESCRIPTION
701742	AR200FP	Furniture fixing pack comprising 2 male/female bolt fixings and 4 wood screws



Architectural Accessories

HOPPE Spare Parts

ID NO	PRODUCT REF	DESCRIPTION
533602	AR200-MALE	M4 x 50mm Loose male bolt from fixing pack 40 to 50mm door thickness
533626	07401-2788-0000	M4 x 70mm Loose male bolt from fixing pack 40 to 70mm door thickness
534722	AR200-FEMALE	M4 x 22mm Loose female receiver bolt from fixing pack



ID NO	PRODUCT REF	DESCRIPTION
630912	AR-GRUB-FULL-SAA	Grub screw to suit full profile spindle (Silver)
817696	AR-GRUB-FULL-PB	Grub screw to suit full profile spindle (Brass)



ID NO	PRODUCT REF	DESCRIPTION
524686	AR-GRUB-SPLIT-SAA	Grub screw to suit HOPPE patented split profile spindle (Silver)
524679	AR-GRUB-SPLIT-PB	Grub screw to suit HOPPE patented split profile spindle (Brass)



ID NO	PRODUCT REF	DESCRIPTION
4379974	09610-0100-0000	Allen key to suit grub screws



ID NO	PRODUCT REF	DESCRIPTION
6938518	06860-3089-0000	Grub screw to suit solid spindle (self tapping)

ID NO	PRODUCT REF	DESCRIPTION
1735228	05600-0101-0000	Spindle & screw pack to suit Dubayy 107L series

General Items

ID NO	PRODUCT REF	DESCRIPTION
8159071	AR2/10-SP-SAA	Spare rose cover to suit AR200S/10 sprung version only (singles)
762712	AR2/10-UN-SAA	Spare rose cover to suit AR200S/10 unsprung version only (singles)
1515527	AR-6/7/8-SLEEVE	Spindle sleeve pack – to adapt 5mm spindle to 6, 7 or 8mm

HOPPE Fixing Accessories

Pull Handle Fixings – Concealed Screw Fixings Ø 20mm

ID NO	PRODUCT REF	DESCRIPTION	FINISH
605422	AR202-H-CF-SAA	Ø 20mm pull handle concealed screw fixing	SAA (F1)

Pull Handle Fixings – Concealed Screw Fixings Ø 22mm

ID NO	PRODUCT REF	DESCRIPTION	FINISH
1668281	AR222-H-CF-SAA	Ø 22mm pull handle concealed screw fixing	SAA (F1)

Pull Handle Fixings – Bolt Through Fixings Ø 20mm and Ø 22mm

ID NO	PRODUCT REF	DESCRIPTION
606122	ARBF-20/22	Ø 20mm/22mm pull handle bolt through fixing set to suit up to 57mm door thickness M8 x 90mm

Pull Handle Back-to-Back Fixings Ø 20mm and Ø 22mm

ID NO	PRODUCT REF	DESCRIPTION
592494	ARBB-20/22-50	Ø 20mm/22mm pull handle back-to-back fixing set to suit up to 50mm door thickness
1707745	ARBB-20/22-60	Ø 20mm/22mm pull handle back-to-back fixing set to suit up to 60mm door thickness

Pull Handle Standard Bolt Fixings Ø 25mm and Ø 30mm

ID NO	PRODUCT REF	DESCRIPTION
618668	ARBF-25/30	Ø 25 mm and Ø 30mm pull handle bolt through fixing set to suit up to 49mm door thickness (pair)

HOPPE Fixing Accessories

Pull Handle Bolt Fixings with Cover Cap Ø 25mm and Ø 30mm

ID NO	PRODUCT REF	DESCRIPTION
6808521	ARBF-25/30-37/47	Ø 25 mm and Ø 30mm pull handle single bolt through fixing with covercap to suit 37mm to 47mm door thickness
829316	ARBF-25/30-47/57	Ø 25 mm and Ø 30mm pull handle single bolt through fixing with covercap to suit 47mm to 57mm door thickness
820641	ARBF-25/30-57/67	Ø 25 mm and Ø 30mm pull handle single bolt through fixing with covercap to suit 57mm to 67mm door thickness
6808562	ARBF-25/30-67/77	Ø 25 mm and Ø 30mm pull handle single bolt through fixing with covercap to suit 67mm to 77mm door thickness
6808570	ARBF-25/30-77/87	Ø 25 mm and Ø 30mm pull handle single bolt through fixing with covercap to suit 77mm to 87mm door thickness
6808596	ARBF-25/30-87/97	Ø 25 mm and Ø 30mm pull handle single bolt through fixing with covercap to suit 87mm to 97mm door thickness

Pull Handle Back-to-Back Fixings Ø 25mm and Ø 30mm

ID NO	PRODUCT REF	DESCRIPTION
600168	ARBB-25/30-44	Ø 25 mm and Ø 30mm pull handle back-to-back fixing to suit up to 44mm door thickness – single bolt (2 required)
763870	ARBB-25/30-57	Ø 25 mm and Ø 30mm pull handle back-to-back fixing to suit up to 57mm door thickness – single bolt (2 required)
646753	ARBB-25/30-67	Ø 25 mm and Ø 30mm pull handle back-to-backfixing to suit up to 67mm door thickness– single bolt (2 required)

Pull Handle Glass Door Fixings Ø 25mm and Ø 30mm

ID NO	PRODUCT REF	DESCRIPTION
763016	ARBF-25-8/13	Ø 25 mm pull handle single bolt through fixing to suit 8mm to 13mm thick glass doors
763054	ARBF-30-8/12	Ø 30 mm pull handle single bolt through fixing to suit 8mm to 12mm thick glass doors
573585	ARBB-25/30-8/13	Ø 25 mm and Ø 30 mm pull handle single back-to-back fixing to suit 8mm to 13mm thick glass doors